

Linear™ Shower Walls

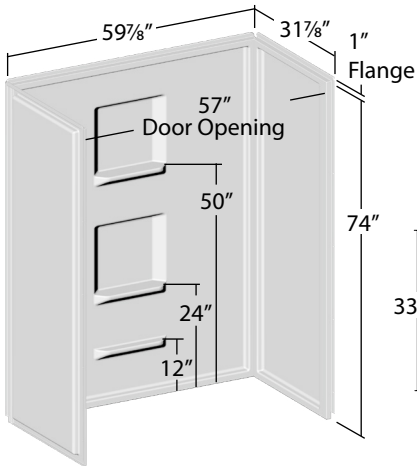

LSUxx603274

Fits most standard 60" x 32" shower bases

6032 Stud Layout

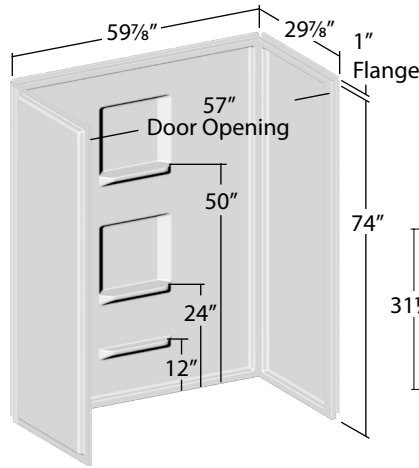
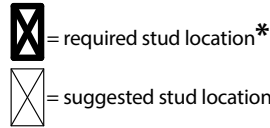
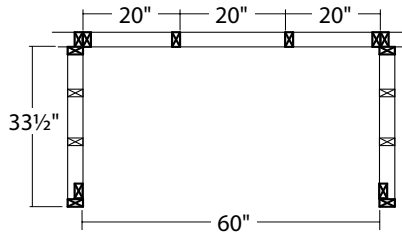

LSUxx603074

Fits most standard 60" x 30" shower bases

6030 Stud Layout

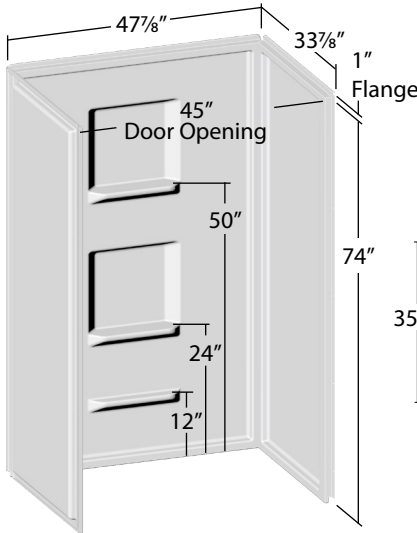
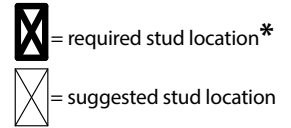
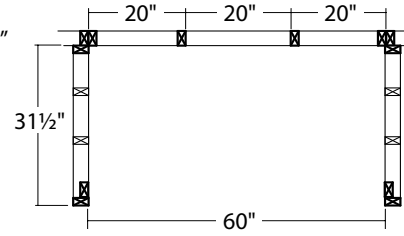

LSUxx483474

Fits most standard 48" x 34" shower bases

4834 Stud Layout

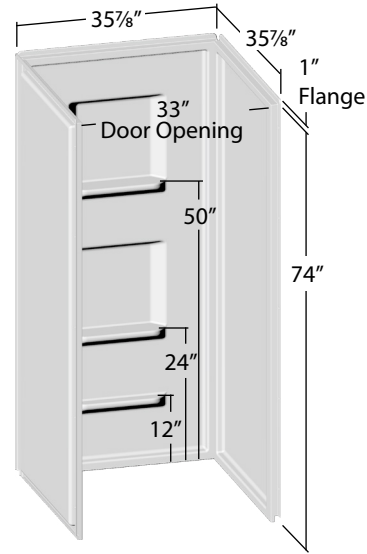
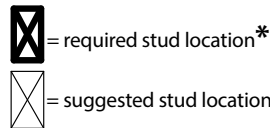
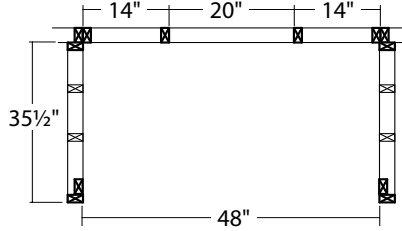

LSUxx363674

Fits most standard 36" x 36" shower bases

3636 Stud Layout

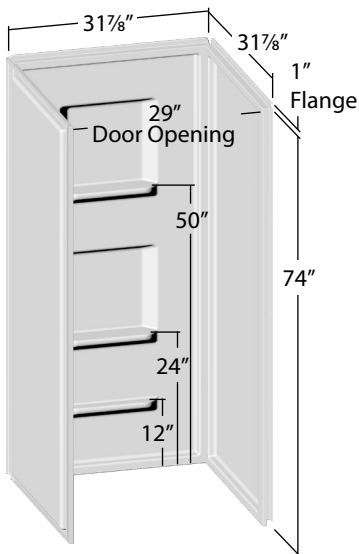
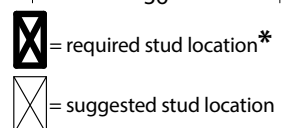
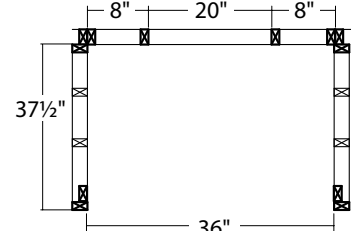

LSUxx323274

Fits most standard 32" x 32" shower bases

3232 Stud Layout

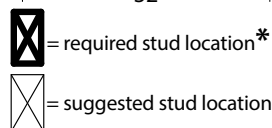
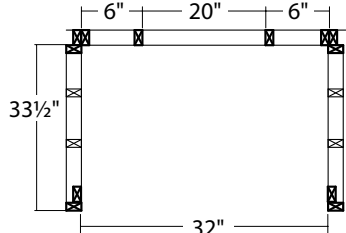

Horizontal stud located at front of alcove required for door installation.

Before installation, peel away protective film along edge of all panels

to ensure correct color
***You may need to cut, move or add studs for shelf placement.**

If installing base and surround in corner alcove, the left or right side panel is not required and can be discarded.

TOOLS YOU WILL NEED

Tape Measure
Level
Square
Drill
Pencil
Safety Glasses
Appropriate Hole or Saber Saw
(for Faucet Installation)

SUPPLIES YOU WILL NEED:

Caulk Gun
6 Tubes of Liquid Nails® or Loctite®
(IMPORTANT: Must be compatible with polystyrene/foam board)
Caulk (for Faucet Installation)
1-5/8" Stainless Steel Screws
2" Masking Tape
Shims
100% Silicone for Faucet

IMPORTANT

- Verify all panels are included before installing. Panel location is marked on top flange. Left panel = LH Right panel = RH
- Read installation instructions carefully before starting project.
- Allow panels to reach room temperature before installation.
- Before you begin determine appropriate product reference (Page 1).
- Seal strips (included) are required for proper installation.
- When installing Lyons walls on a shower base from another manufacturer caulk is required.
- Do not use plumber's putty. Will cause product failure and void warranty. Use a high grade silicone caulk for all necessary locations.
- Keep instructions for warranty information and copy of receipt.
- Horizontal stud located at front of alcove required for door installation.

STEP 1. PREPARING ALCOVE

- a. Strip alcove to bare studs.
- b. Stud pocket should be constructed as shown on page 1. You may need to cut, move or add studs for shelf placement. Studs must be plumb and square to sub-floor. Sub-floor must be level. (Fig. 1)
- c. Check that there are no screws, nails or staples in the studs that will interfere with installation.
- d. If installing over existing shower base check that studs are plumb to the shower base and shower base is level. Go to step 3.
- e. If desired, add appropriate rated insulation between studs.

STEP 2. SHOWER BASE INSTALLATION

- a. Follow manufacturer's instructions for installing your shower base.

IMPORTANT — Shower base must be plumb and square to alcove for proper wall installation

STEP 3. INSTALL SEAL STRIP

- a. Carefully separate (NOTE: PULL APART - DO NOT CUT) seal strip. (Fig. 2)
- b. Peel back protective film along all edges of back panel.
- c. Place seal strip along both sides of back panel removing protective paper as you apply. (Fig. 3)

IMPORTANT - DO NOT STRETCH SEAL STRIP!

- d. Apply pressure along the entire length of each seal strip to activate adhesive. Trim any excess.

NOTE: Failure to install seal strip will cause water damage and void warranty If seal strip is missing, please contact customer support before installing

STEP 4. TRIAL FIT PANELS

- a. All panels must fully contact required studs as shown on page 1. (Fig. 4)
- b. Place back panel then fit side panels into place. (Fig. 5)
- c. Center wall on shower base. Make sure panels rest flat on shower base.
- d. If necessary, shim between panels and studs to provide a tight fit between the back and side panels. (Fig. 6)
- e. Align the front of the side walls to the front of the shower base. This makes drywall installation easier.
- f. Mark height of wall on each stud to indicate where to apply adhesive on the stud. (Fig. 7)
- g. Measure and mark all control holes. After removing side panels, drill or saw necessary holes.

IMPORTANT — Drill or saw holes from front side. Cover area to be cut with masking tape to prevent chipping and scratching

IMPORTANT --- Use 100% silicone on faucet.

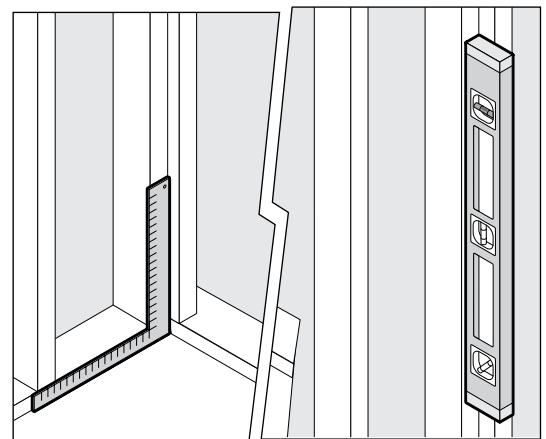

FIGURE 1. Check that studs are plumb with sub-floor/base.

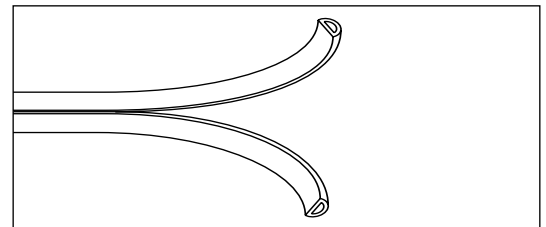

FIGURE 2. Carefully separate seal strip. **DO NOT CUT!**

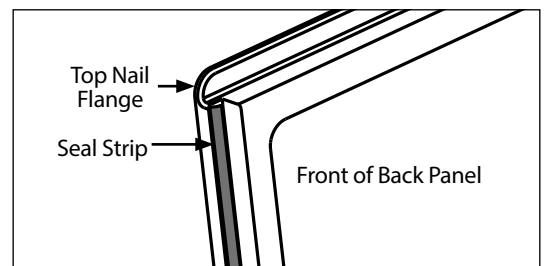

FIGURE 3. Place seal strip on both sides of back panel.

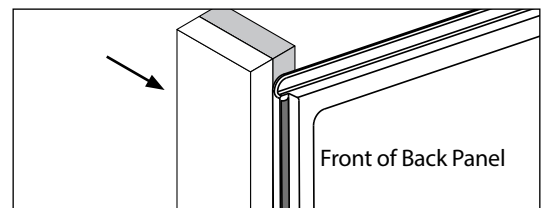

FIGURE 4. All panels must fully contact required studs.

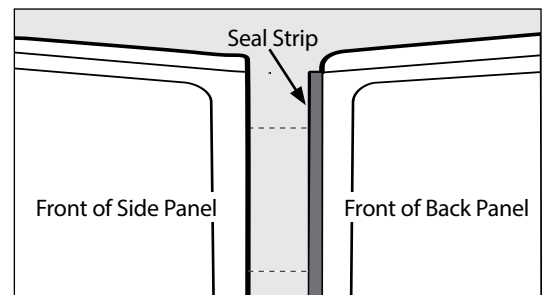

FIGURE 5. Fit side panels into place on back wall panel.

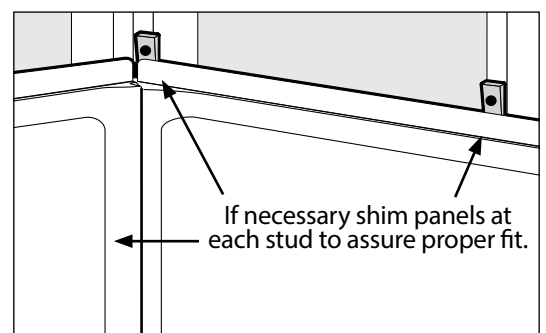

FIGURE 6. You can shim against the stud.

STEP 5. INSTALLING SHOWER WALL IN ALCOVE

- Peel back protective film along bottom edge of back and side panels.
- Apply a generous bead of adhesive below mark on each back panel stud only (follow adhesive manufacturer's recommended instructions).
- Place back panel and center on base.
- Apply adhesive to studs for side panel opposite the shower controls and place side panel.
- Apply adhesive to studs for faucet side panel and place side panel. (Fig. 8)
- Center wall panels on shower base. Make sure panels are resting flat on base.
- Reposition shims if needed.
- Press back panel firmly into place and align the front of the side walls to the front of the shower base and screw back panel nail flange to studs.
- Apply pressure to one side panel, directing the pressure towards back panel, then screw vertical nail flange to stud. Repeat for opposite side panel.
- Screw top flange of side panels to studs.
- Apply pressure to secure all panels to studs while adhesive dries.

NOTE: If installing base and surround in corner alcove, the opposite panel can be discarded (Fig. 9)

IMPORTANT - Failure to adhere panels and screw all flanges to all studs will void warranty

STEP 6. CAULKING

- When installed on any Lyons shower base your Linear™ wall is designed to function properly without seams being caulked.
- Caulk must be applied around holes for the faucet, diverter valve and shower head.
- If your Linear™ wall is used on a shower base other than a Lyons, it is required to caulk all seams.

STEP 7. FINISHING

Green Board or Other Finishing Boards

- Shim studs with lattice strips or 1/4" luan so that finishing board will overlap nail flanges. (Fig. 10)

Tile

- Install finishing board up to (not over) nail flanges.
- Install tile over finishing board and nail flanges.

CLEANING

- Do not use any abrasive cleaners or metal scrapers.
- If drywall mud or plaster gets on a finished surface it may be carefully removed with a wooden scraper made from a piece of scrap wood.
- Adhesive may be removed with mineral spirits.
- Ideal cleaners are Soft Scrub Gel®, Comet Gel® or 409®.

WARNING: Some cleaning products are not suitable for use. Read all labels carefully. DO NOT USE if they say "not suitable for use with ABS, acrylic or polystyrene". Always rinse cleansers thoroughly within five minutes of application.

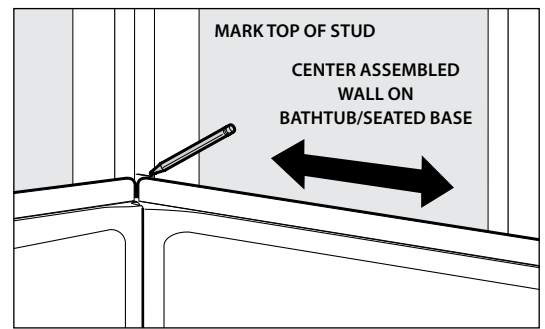

FIGURE 7. Mark studs.

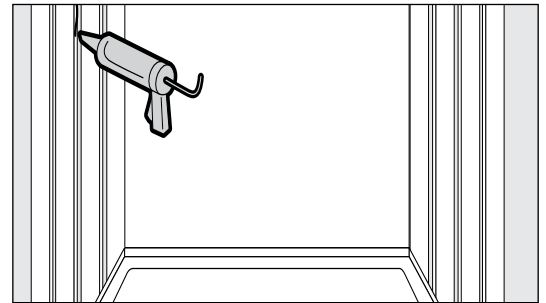

FIGURE 8. Apply adhesive.

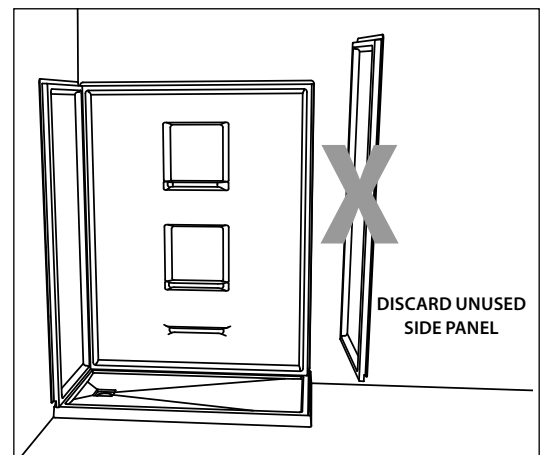

FIGURE 9. If installing in corner alcove, discard side panel not being used.

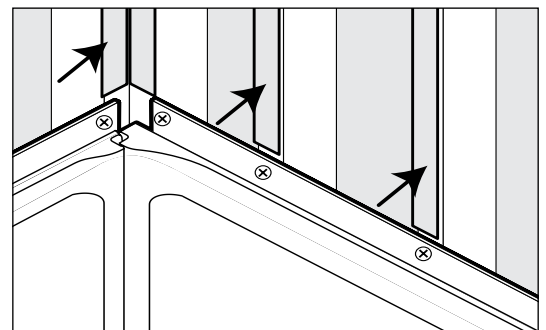

FIGURE 10. Shim studs.

**DO NOT RETURN PRODUCT OR CONTACT STORE!
FOR QUESTIONS OR CONCERNS**

please call or e-mail our customer support team

1-800-458-9036

lyonssupport@lyonsindustries.com

LYONS FIXTURE — LIMITED WARRANTY
10-YEAR CONSUMER, 3-YEAR COMMERCIAL

Lyons Industries, Inc. warrants to the original purchaser that this Lyons fixture will be free of manufacturing defects, which affect its performance as a bathing or showering fixture, under the following conditions and subject to the limitations contained in the "Remedies" and "Warranty Limitations" sections. The Limited Warranty applies for 10 years from the date of purchase if the fixture is used in a residential owner-occupied building for non-commercial purposes; or for 3 years from the date of purchase if it is used in any other building, including any building used for rental, commercial or business purposes. This Limited Warranty is void if the fixture is not installed in accordance with the installation instructions supplied by Lyons or local building codes and ordinances or if the care and cleaning instructions supplied by Lyons are not followed. This Limited Warranty is also void if the fixture is moved from the location of its initial installation or is subjected to accident, abuse or misuse. The Limited Warranty excludes normal wear and tear and does not cover damage that can be repaired by following the Scratch Removal Instructions. This Limited Warranty shall be void unless any failure or non-conformance is discovered before the expiration of this warranty and is reported to Lyons, in writing, accompanied by the original proof of purchase, within 30 days of discovery, to: Lyons Industries, Inc., 30000 M-62 West, Dowagiac, Michigan 49407

REMEDIES — The original purchaser's remedy under this Limited Warranty is limited to the repair, replacement or refund of the purchase price of the fixture, at Lyons' sole option, of any part of the fixture which has failed or does not conform to the manufacturer's specifications. In no event shall Lyons be liable for lost profits, loss of use, incidental, special or consequential damages including, but not limited to, damage to or loss of use of the building or its contents, arising out of any defect in the fixture; nor shall Lyons be liable for any amount in excess of the original purchase price of the fixture. Lyons reserves the right to require the return, at purchaser's expense, of the damaged fixture for repair or exchange before providing services under this Limited Warranty. If Lyons elects to replace the fixture, its obligation is limited to supplying a replacement unit or component part of comparable size and style, and does not include the cost of removal, installation, or transportation, which must be borne by the purchaser. Replacement parts provided under this Limited Warranty are warranted for the remainder of the original warranty period applicable to the fixture, as if such parts were original components of that fixture.

WARRANTY LIMITATIONS — THERE ARE NO WARRANTIES WHICH EXTEND BEYOND THE DESCRIPTION ON THE FACE HEREOF. IMPLIED WARRANTIES, INCLUDING THOSE OF MERCHANTABILITY OR FITNESS FOR A PARTICULAR PURPOSE, ARE EXPRESSLY DISCLAIMED. LYONS DISCLAIMS ANY AND ALL LIABILITY FOR SPECIAL, INCIDENTAL OR CONSEQUENTIAL DAMAGES. Some states do not allow limitations of incidental or consequential damages, so the above limitations and exclusions may not apply to you. In such states, Lyons' liability shall be limited to the extent permitted by state law. ANY IMPLIED WARRANTIES ARISING BY WAY OF STATE LAW, INCLUDING ANY IMPLIED WARRANTY OF MERCHANTABILITY OR ANY IMPLIED WARRANTY OF FITNESS FOR A PARTICULAR PURPOSE, ARE LIMITED IN DURATION AND IN SCOPE OF COVERAGE TO THE TERMS OF THIS LIMITED WARRANTY, UNLESS A SHORTER PERIOD IS ALLOWED BY LAW.

SCRATCH REMOVAL INSTRUCTIONS

1. For effective scratch removal and polishing, you will need to purchase these items.

- 1 sheet 1000 grit 3M® wet-dry sandpaper
- 1 sheet 1500 grit 3M® wet-dry sandpaper
- 1 sheet 2000 grit 3M® wet-dry sandpaper
- 1 small container of 3M® rubbing compound

These items can be purchased at most auto supply stores that provide supplies to professional paint and body shops. Call before you go. Not all auto supply stores will have these items.

2. Start sanding with 2000 grit paper. Use small squares of paper about 2"x 2" for all sanding and use lots of water. The water serves as both a lubricant and to prevent residue buildup on the paper. Residue buildup shortens the effective life of the paper and may scratch the surface you're trying to polish.
3. 2000 grit paper is the finest grit available (the higher the number, the finer the grit). If you can't remove all of the scratches with 2000 grit, switch to 1500 grit. Remember to wash the paper frequently with water as you sand.
4. If all of the scratches can't be removed with 1500 grit, switch to 1000 grit. This should remove most fine scratches. If you have deep scratches or a gouge, coarser paper may have to be used (see chart to right). Be careful! Using grit that is too coarse may actually put in more scratches than it removes.
5. Once you have removed all of the scratches, by sanding with the finest paper possible, repeat the sanding process using successively finer grits of paper until you've once again sanded with 2000 grit.
6. Now use 3M® rubbing compound on a soft, damp cloth. Polish using considerable pressure to produce a smooth, shiny finish.



SCRATCH / SANDPAPER GUIDE

COMPLIANCE CERTIFICATIONS:

CAN/ULC S102.2 FLAME-75
MOKE DEVELOPED-485 CODE

Lyons Industries, Inc.
30000 M-62 West, Dowagiac, MI 49407
phone (800) 458-9036 fax (269) 782-5159
lyonsindustries.com
e-mail lyonsind@lyonsindustries.com